

STD60GKXX

Thyristor-Diode Modules



Type	V_{RSM}	V_{RRM}
	V_{DSM}	V_{DRM}
	V	V
STD60GK08	900	800
STD60GK12	1300	1200
STD60GK14	1500	1400
STD60GK16	1700	1600
STD60GK18	1900	1800

Dimensions in mm (1mm=0.0394")

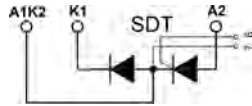
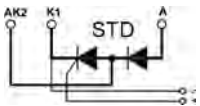
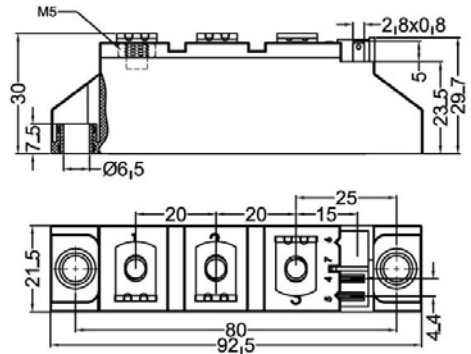

Symbol	Test Conditions	Maximum Ratings	Unit
I_{TRMS}, I_{FRMS} I_{TAVM}, I_{FAVM}	$T_{VJ}=T_{VJM}$ $T_C=85^{\circ}C; 180^{\circ}$ sine	100 60	A
I_{TSM}, I_{FSM}	$T_{VJ}=45^{\circ}C$ $V_R=0$ $t=10ms$ (50Hz), sine $t=8.3ms$ (60Hz), sine	1500 1600	A
	$T_{VJ}=T_{VJM}$ $V_R=0$ $t=10ms$ (50Hz), sine $t=8.3ms$ (60Hz), sine	1350 1450	
$\int i^2 dt$	$T_{VJ}=45^{\circ}C$ $V_R=0$ $t=10ms$ (50Hz), sine $t=8.3ms$ (60Hz), sine	11200 10750	A ² s
	$T_{VJ}=T_{VJM}$ $V_R=0$ $t=10ms$ (50Hz), sine $t=8.3ms$ (60Hz), sine	9100 8830	
$(di/dt)_{cr}$	$T_{VJ}=T_{VJM}$ $f=50Hz, t_p=200\mu s$ $V_D=2/3V_{DRM}$ $I_G=0.45A$ $di_G/dt=0.45A/\mu s$	repetitive, $I_T=150A$ 150	A/ μs
		non repetitive, $I_T=I_{TAVM}$ 500	
$(dv/dt)_{cr}$	$T_{VJ}=T_{VJM};$ $R_{GK}=\infty;$ method 1 (linear voltage rise)	$V_{DR}=2/3V_{DRM}$ 1000	V/ μs
P_{GM}	$T_{VJ}=T_{VJM}$ $I_T=I_{TAVM}$	$t_p=30\mu s$ 10	W
		$t_p=300\mu s$ 5	
P_{GAV}		0.5	W
V_{RGM}		10	V
T_{VJ} T_{VJM} T_{stg}		-40...+125	$^{\circ}C$
		125	
		-40...+125	
V_{ISOL}	50/60Hz, RMS $I_{ISOL} \leq 1mA$	$t=1min$ 3000	V~
		$t=1s$ 3600	
M_d	Mounting torque (M5) Terminal connection torque (M5)	2.5-4.0/22-35	Nm/lb.in.
		2.5-4.0/22-35	
Weight	Typical	78	g



STD60GKXX

Thyristor-Diode Modules

Symbol	Test Conditions	Characteristic Values	Unit
I_{RRM}, I_{DRM}	$T_{VJ}=T_{VJM}; V_R=V_{RRM}; V_D=V_{DRM}$	5	mA
V_T, V_F	$I_T, I_F=200A; T_{VJ}=25^{\circ}C$	1.57	V
V_{TO}	For power-loss calculations only ($T_{VJ}=125^{\circ}C$)	0.85	V
r_T		3.7	$m\Omega$
V_{GT}	$V_D=6V;$ $T_{VJ}=25^{\circ}C$ $T_{VJ}=-40^{\circ}C$	1.5 1.6	V
I_{GT}	$V_D=6V;$ $T_{VJ}=25^{\circ}C$ $T_{VJ}=-40^{\circ}C$	100 200	mA
V_{GD}	$T_{VJ}=T_{VJM};$ $V_D=2/3V_{DRM}$	0.2	V
I_{GD}		10	mA
I_L	$T_{VJ}=25^{\circ}C; t_p=10\mu s; V_D=6V$ $I_G=0.45A; di_G/dt=0.45A/\mu s$	450	mA
I_H	$T_{VJ}=25^{\circ}C; V_D=6V; R_{GK}=\infty$	200	mA
t_{gd}	$T_{VJ}=25^{\circ}C; V_D=1/2V_{DRM}$ $I_G=0.45A; di_G/dt=0.45A/\mu s$	2	μs
t_q	$T_{VJ}=T_{VJM}; I_T=150A; t_p=200\mu s; -di/dt=10A/\mu s$ $V_R=100V; dv/dt=20V/\mu s; V_D=2/3V_{DRM}$	150	μs
Q_S	$T_{VJ}=T_{VJM}; I_T, I_F=50A; -di/dt=3A/\mu s$	100	μC
I_{RM}		24	A
R_{thJC}	per thyristor/diode; DC current per module	0.45 0.225	K/W
R_{thJK}	per thyristor/diode; DC current per module	0.65 0.325	K/W
d_s	Creeping distance on surface	12.7	mm
d_A	Strike distance through air	9.6	mm
a	Maximum allowable acceleration	50	m/s^2

FEATURES

- * International standard package
- * DCB base plate
- * Glass passivated chips
- * Isolation voltage 3600 V~
- * UL File NO.E310749
- * RoHS compliant

APPLICATIONS

- * DC motor control
- * Softstart AC motor controller
- * Light, heat and temperature control

ADVANTAGES

- * Space and weight savings
- * Simple mounting with two screws
- * Improved temperature and power cycling
- * Reduced protection circuits



STD60GKXX

Thyristor-Diode Modules

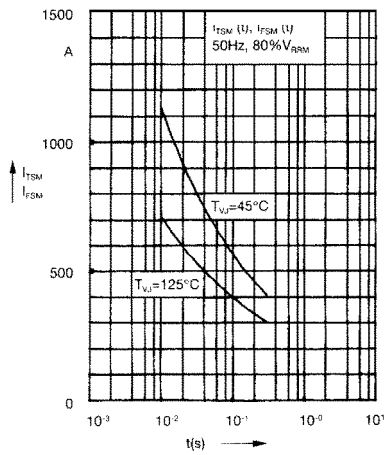

Fig. 1 Surge overload current
 I_{TSM} , I_{FSM} : Crest value, t : duration

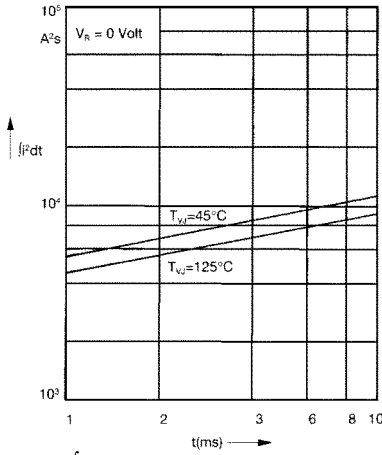

Fig. 2 $\int i^2 dt$ versus time (1-10 ms)

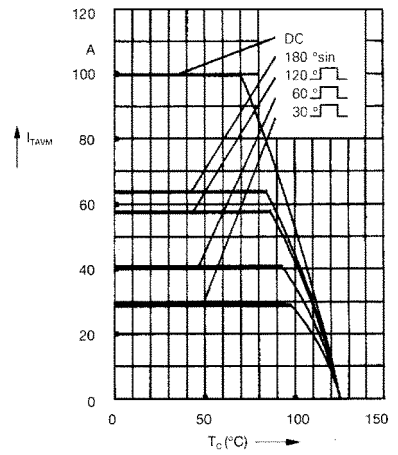

Fig. 2a Maximum forward current at case temperature

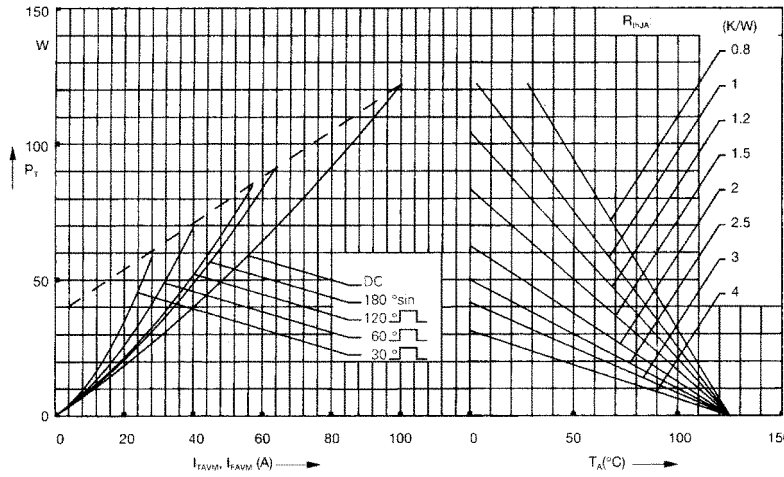

Fig. 3 Power dissipation versus on-state current and ambient temperature (per thyristor or diode)

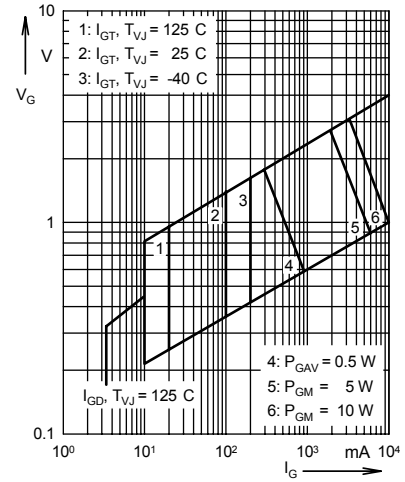

Fig. 4 Gate trigger characteristics

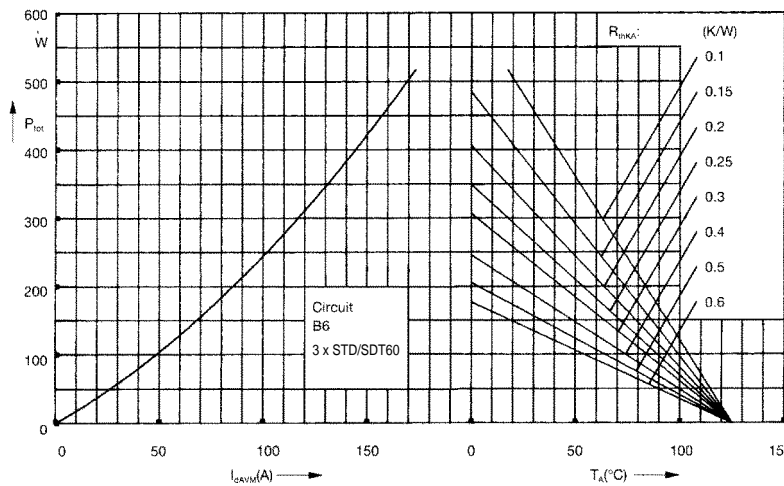

Fig. 5 Three phase rectifier bridge: Power dissipation versus direct output current and ambient temperature

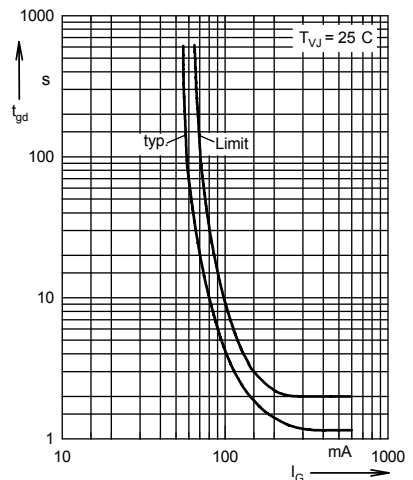

Fig. 6 Gate trigger delay time



STD60GKXX

Thyristor-Diode Modules

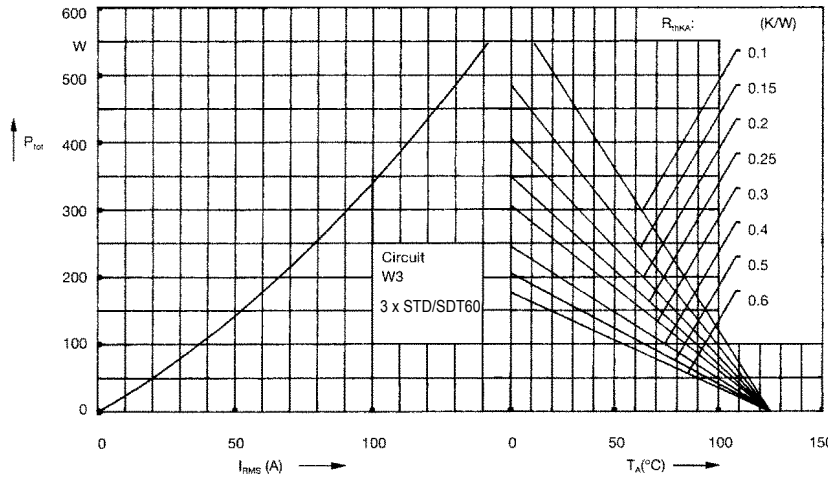

Fig. 7 Three phase AC-controller: Power dissipation versus RMS output current and ambient temperature

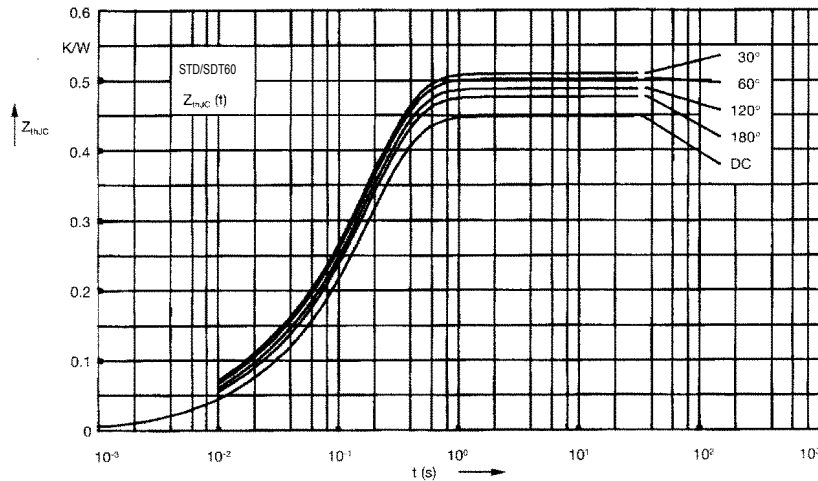

Fig. 8 Transient thermal impedance junction to case (per thyristor or diode)

R_{thJC} for various conduction angles d:

d	R_{thJC} (K/W)
DC	0.45
180°C	0.47
120°C	0.49
60°C	0.505
30°C	0.52

Constants for Z_{thJC} calculation:

i	R_{thi} (K/W)	t_i (s)
1	0.014	0.015
2	0.026	0.0095
3	0.41	0.175

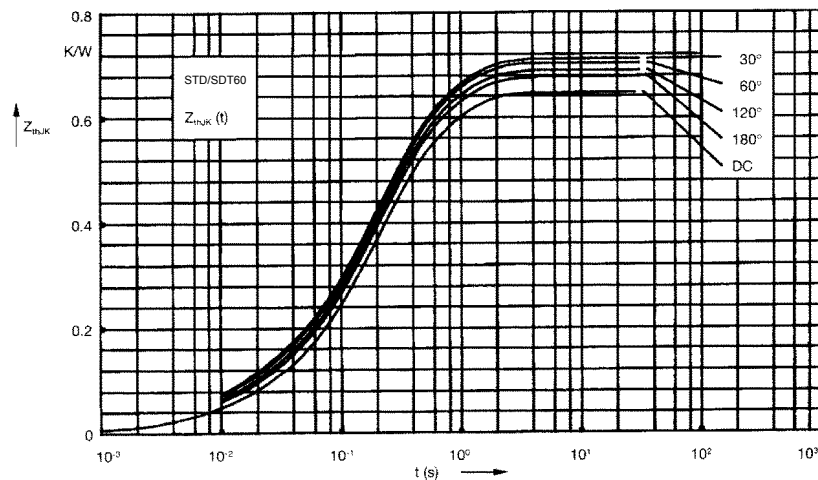

Fig. 9 Transient thermal impedance junction to heatsink (per thyristor or diode)

R_{thJK} for various conduction angles d:

d	R_{thJK} (K/W)
DC	0.65
180°C	0.67
120°C	0.69
60°C	0.705
30°C	0.72

Constants for Z_{thJK} calculation:

i	R_{thi} (K/W)	t_i (s)
1	0.014	0.015
2	0.026	0.0095
3	0.41	0.175
4	0.2	0.67

